

3. INSPECTION/ADJUSTMENT

3

INSPECTION / ADJUSTMENT

SERVICE INFORMATION----- 3- 1
 MAINTENANCE SCHEDULE----- 3- 2
 THROTTLE OPERATION ----- 3- 3
 ENGINE OIL ----- 3- 4
 RESERVE TANK ----- 3- 5
 AIR CLEANER ----- 3- 6
 SPARK PLUG ----- 3- 6
 VALVE CLEARANCE----- 3- 7
 CYLINDER COMPRESSION ----- 3- 7
 FINAL REDUCTION GEAR OIL ----- 3- 8
 DRIVE BELT ----- 3- 8
 BRAKE SYSTEM ----- 3- 9
 CLUTCH SHOE WEAR ----- 3- 10
 SUSPENSION ----- 3- 10
 NUTS/BOLTS/FASTENERS----- 3- 11
 WHEELS/TIRES ----- 3- 11
 STEERING HANDLEBAR ----- 3- 11
 SIDE STAND ----- 3- 12

3. INSPECTION/ADJUSTMENT

SERVICE INFORMATION

GENERAL

 WARNING
--

- Before running the engine, make sure that the working area is well ventilated. Never run the engine in a closed area. The exhaust contains poisonous carbon monoxide gas, which may cause death to people.
- Gasoline is extremely flammable and is explosive under some conditions. The working area must be well ventilated and do not smoke or allow flames or sparks near the working area or fuel storage area.

SPECIFICATIONS

ENGINE

Throttle grip free play : 2~6 mm
 Spark plug : NGK: CR7E
 Spark plug gap : 0.6 mm ~ 0.7 mm
 Valve clearance : IN: 0.10 mm EX: 0.10 mm
 Idle speed : 1600±100 rpm

Engine oil capacity:

Cylinder compression: 16±2 kg/cm²
 At disassembly : 1.5 Liter Ignition timing : ECU
 At change : 1.3 Liter Coolant type : Water Cooling

Gear oil capacity :

At disassembly : 0.23 Liter
 At change : 0.21 Liter

TIRE

	1 Rider	2 Riders
Front	2.00 kg/cm ²	2.00 kg/cm ²
Rear	2.25 kg/cm ²	2.25 kg/cm ²

TIRE SPECIFICATION

Front : 120/80-14 58S
 Rear : 150/70-13 64S

TORQUE VALUES

Front axle nut : 2 kg-m
 Rear axle nut : 12 kg-m

SPECIAL TOOL

Tappet Adjuster E012

3. INSPECTION/ADJUSTMENT

Maintenance schedule

Perform the pre-ride inspection (see page 21) at each scheduled maintenance period. This interval should be judged by odometer reading or months, whichever comes first.

Maintenance schedule legend

I: INSPECT AND CLEAN, ADJUST, LUBRICATE OR REPLACE IF NECESSARY

C: CLEAN R: REPLACE A: ADJUST L: LUBRICATE

The maintenance schedule on the following two pages specifies the maintenance required to keep your **DOWNTOWN 300i** scooter in peak operating condition. Maintenance work should be performed in accordance with KYMCO standards and specifications by properly trained and equipped technicians. Your KYMCO dealer meets all of these requirements.

- * Should be serviced by your KYMCO dealer, unless you have the proper tools, service data and are technically qualified.
- ** In the interest of safety, we recommend these items be serviced only by your KYMCO dealer. KYMCO recommends that your KYMCO dealer road test your scooter after each periodic maintenance service is completed.

ITEM		FREQUENCY	WHICHEVER COMES FIRST	ODOMETER READING									
				X 1000 km	1	5	10	15	20	25	30		
				X 1000 mi	0.6	3	6	9	12	15	18		
				MONTH	1	6	12	18	24	30	36		
*	AIR CLEANER					R	R	R	R	R	R	R	R
	SPARK PLUGS					I	R	I	R	I	R		
*	THROTTLE OPERATION					I	I	I	I	I	I	I	I
*	VALVE CLEARANCE					I	A	I	A	I	A		
*	FUEL LINE						I		I		I		
	CRANKCASE BREATHER				C	C	C	C	C	C	C	C	C
*	ENGINE OIL				R	R	R	R	R	R	R	R	R
*	ENGINE OIL SCREEN					C	R	C	R	C	R		
*	ENGINE OIL FILTER				R	R	R	R	R	R	R	R	R
*	ENGINE IDLE SPEED						I		I		I		
*	TRANSMISSION OIL				R	R	R	R	R	R	R	R	R
*	DRIVE BELT					I	I	I	I	I	I	I	I
**	CLUTCH SHOE WEAR						I		I		I		
	BRAKE FLUID					I	R	I	R	I	R		
	BRAKE PAD WEAR					I	I	I	I	I	I	I	I
	BRAKE SYSTEM					I	I	I	I	I	I	I	I
*	BRAKE LIGHT SWITCH					I	I	I	I	I	I	I	I
**	STEERING BEARINGS					I	I	I	I	I	I	I	I
*	HEADLIGHT AIM					I	I	I	I	I	I	I	I
*	NUTS, BOLTS, FASTENERS					I	I	I	I	I	I	I	I
**	WHEELS/TIRES					I	I	I	I	I	I	I	I
**	COOLANT					I	R	I	R	I	R		

3. INSPECTION/ADJUSTMENT

THROTTLE OPERATION

Check the throttle grip for smooth movement.
Measure the throttle grip free play.

Free Play: 2~6 mm

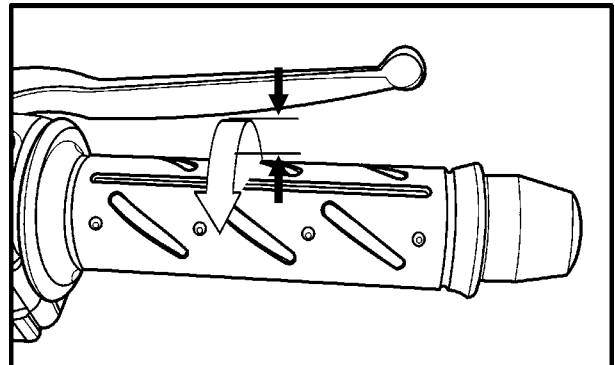

Major adjustment of the throttle grip free play is made with the adjusting nut at the throttle body side. Adjust by loosening the lock nut and turning the adjusting nut.

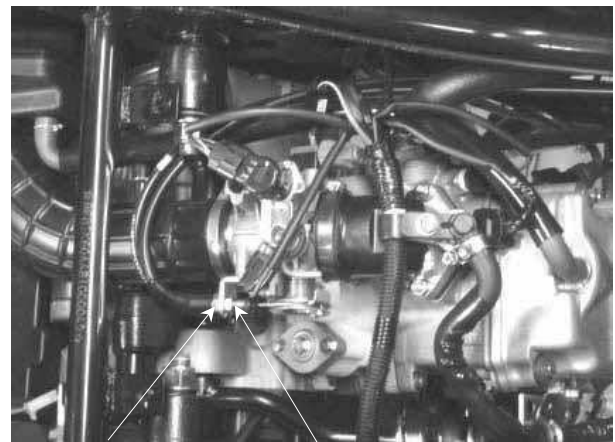

Minor adjustment is made with the adjusting nut at the throttle grip side. Slide the rubber cover(1) out and adjust by loosening the lock nut(3) and turning the adjusting nut(2).

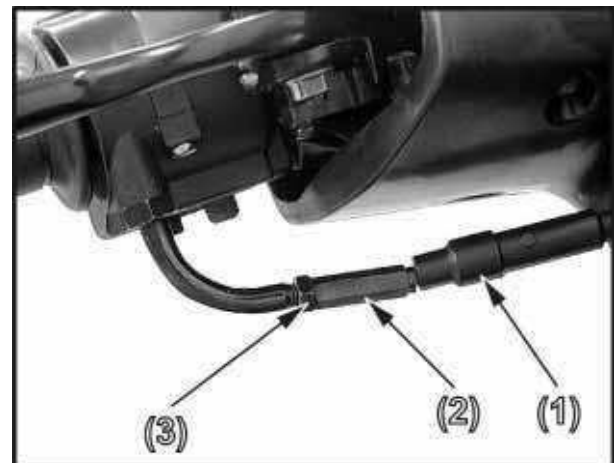

3. INSPECTION/ADJUSTMENT

ENGINE OIL

OIL LEVEL INSPECTION

Stop the engine and support the scooter upright on the level ground.
 Wait for 2~3 minutes and check the oil level with the dipstick. Do not screw in the dipstick when checking the oil level.

OIL CHANGE

Remove the oil drain bolt to drain the engine oil.
 Install the aluminum washer and tighten the oil drain bolt.

Torque: 2.5 kg-m

- * • Replace the aluminum washer with a new one if it is deformed or damaged.

Pour the recommended oil through the oil filler hole.

OIL CAPACITY

Engine oil capacity: 1.5 L
 Engine oil exchanging capacity: 1.3 L
 Engine Oil Viscosity : SAE 5W50

OIL FILTER SCREEN INSPECTION

Drain the engine oil.
 Remove the oil filter screen attaching the left-under crankcase.
 Clean the oil filter screen.
 Install the oil filter screen and filter screen cap.

Fill the engine with recommended engine oil.

OIL FILTER REPLACEMENT

Remove the oil filler cap attaching the right-under crankcase cover.



Oil Drain Bolt



Oil Filter Screen

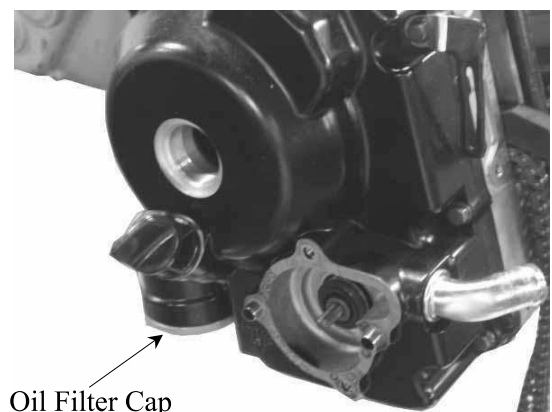

Oil Filter Cap

3. INSPECTION/ADJUSTMENT

The spring will come out when the filter cap is removed.

Let the engine oil drain out.

Check that the O-ring is in good condition.



Spring

Install a new oil filter.

* Make sure the rubber seal on the oil filter facing the left crankcase.



RESERVE TANK COOLANT LEVEL INSPECTION

The reserve tank is under left floorboard .Check the coolant level through the inspection window(1) at the left side skirt while the engine is at the normal operating temperature , with the scooter In an upright position.

If the coolant level is below the LOWER level mark(3), remove the left floor mat ,remove the lid screw(4), the reserve tank lid(5), and then the reserve tank cap(6) to add coolant mixture until it reaches the upper level mark

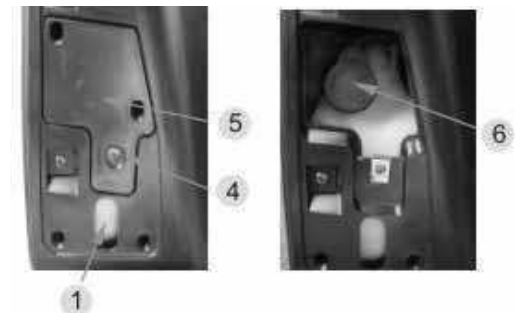

* Add coolant to the reserve tank only. Do not attempt to add coolant by removing the radiator cap. Coolant in the radiator is under pressure and is very hot and can cause serious burns.



3. INSPECTION/ADJUSTMENT

AIR CLEANER

AIR FILTER REPLACEMENT

Remove the body cover.
 Remove seven screws attaching to the air cleaner cover.
 Remove six screws attaching to the filter.
 Check the filter and replace it if it is excessively dirty or damaged.



Air Cleaner Cover

CHANGE INTERVAL

More frequent replacement is required when riding in unusually dusty or rainy areas.

- * • The air cleaner element has a viscous type paper element. Do not clean it with compressed air.
 • Be sure to install the air cleaner element and cover securely.

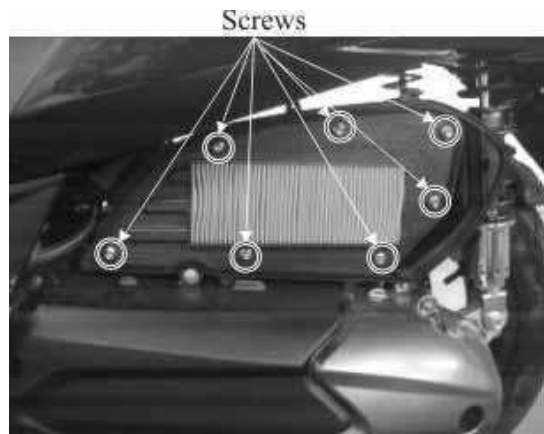

SPARK PLUG

Remove the spark plug cap and spark plug.
 Check the spark plug for wear and fouling deposits.
 Clean any fouling deposits with a spark plug cleaner or a wire brush.

Specified Spark Plug: NGK-CR7E

Measure the spark plug gap.

Spark Plug Gap: 0.6 – 0.7 mm

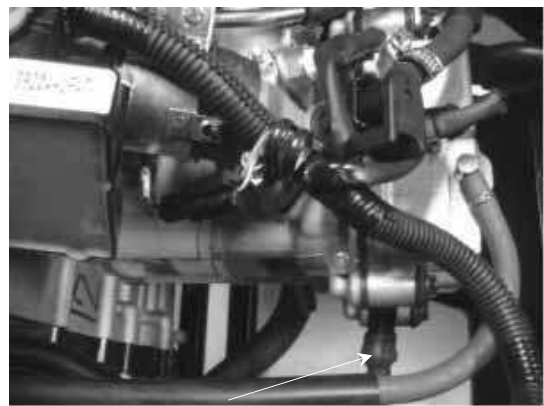

Spark Plug

- * • When installing, first screw in the spark plug by hand and then tighten it with a spark plug wrench.

Torque: 17.2 N-m

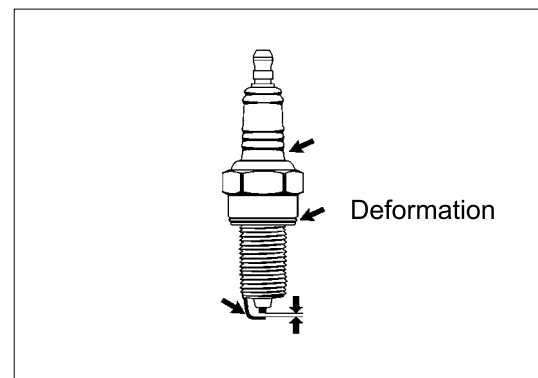

3. INSPECTION/ADJUSTMENT

VALVE CLEARANCE

- * • Inspect and adjust valve clearance while the engine is cold (below 35°C).

Remove the seat assy and luggage box.
Remove the four bolts and then cylinder head cover.

Turn the A.C. generator flywheel to the top dead center (TDC) on the compression stroke so that the "T" mark on the flywheel aligns with the index mark on the left crankcase cover.

Inspect and adjust valve clearance.

Valve Clearance: IN: 0.10 mm
EX: 0.10 mm

Loosen the lock nut and adjust by turning the adjusting nut



Valve Adjuster E012
Feeler Gauge

- * • Check the valve clearance again after the lock nut is tightened.

Cylinder Head Cover

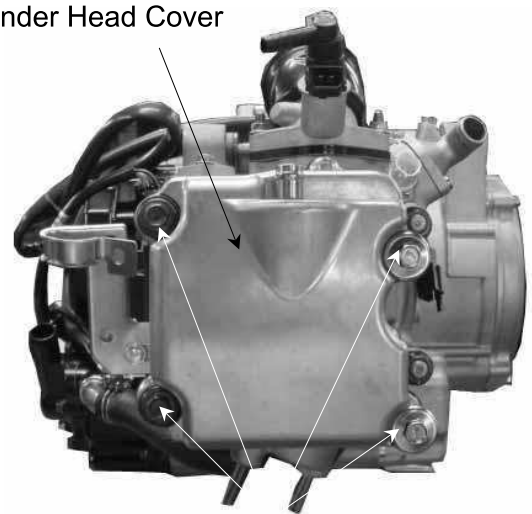

Bolts

Top Dead Center Mark



CYLINDER COMPRESSION

Warm up the engine before compression test.

Remove the center cover and luggage box.
Remove the spark plug.
Insert a compression gauge.
Open the throttle fully and push the starter button to test the compression.

Max. Compression: 16±2 kg/cm² - 570 rpm

If the compression is low, check for the following:

- Leaky valves
- Valve clearance too small
- Leaking cylinder head gasket
- Worn piston rings
- Worn piston/cylinder

If the compression is high, it indicates that carbon deposits have accumulated on the combustion chamber and the piston head.

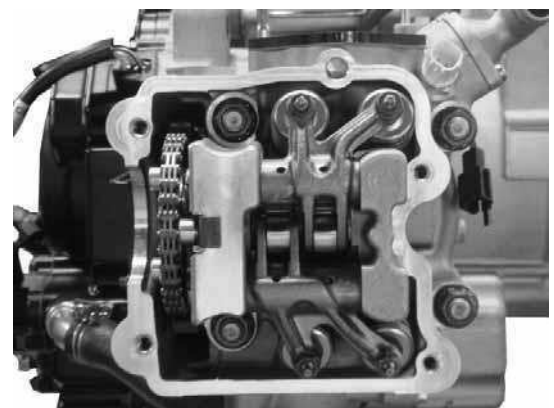

3. INSPECTION/ADJUSTMENT

FINAL REDUCTION GEAR OIL

- * Place the scooter on its main stand on level ground.

Remove the transmission fluid drain bolt. Remove the transmission fluid filler bolt, then slowly rotate the rear wheel to drain the fluid. Fill the transmission with the recommend fluid to the capacity listed below.

Transmission fluid type: SAE 90

Transmission fluid capacity: 0.23 L

Transmission fluid exchanging capacity: 0.21 L

Install the transmission filler bolt and tighten it to the specified torque.



Oil Drain Bolt

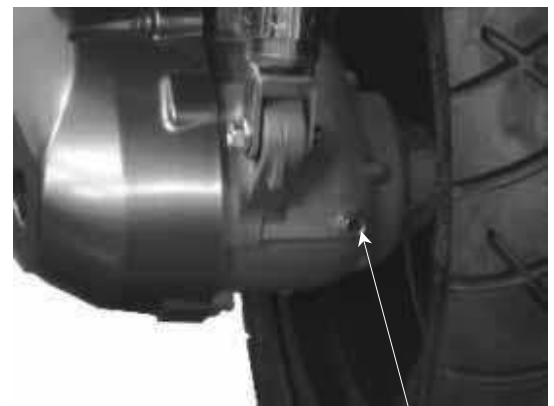

Oil Filler Bolt

DRIVE BELT

Remove the left crankcase cover. Inspect the drive belt for cracks or excessive wear. Replace the drive belt with a new one if necessary and in accordance with the Maintenance Schedule.

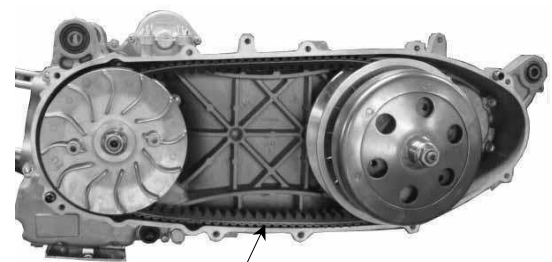

Drive Belt

3. INSPECTION/ADJUSTMENT

BRAKE SYSTEM

There is adjuster on each brake lever. Each adjuster has four positions so that the released lever position can be adjusted to suit the rider's hands.

To adjust the distance of the lever from the handlebar grip, push the lever(1) forward and turn the adjuster knob(2) to align the number with the arrow mark(3) on the lever holder.



BRAKE DISK/BRAKE PAD

Check the brake disk surface for scratches, unevenness or abnormal wear.

Check if the brake disk runout is within the specified service limit.

Check if the brake pad wear exceeds the wear indicator line.

Front Brake disk

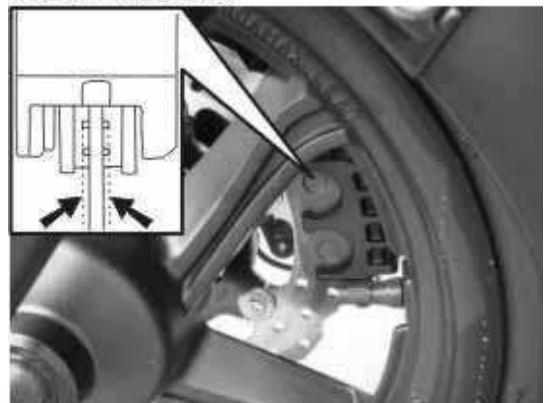

Rear Brake disk



* Keep grease or oil off the brake disk to avoid brake failure.

BRAKE FLUID

Turn the steering handlebar upright and check if both brake fluid levels is at the upper limit. If the brake fluid is insufficient, fill to the upper limit.

Specified Brake Fluid: DOT-4

* The brake fluid level will decrease if the brake pads are worn.

Brake fluid reservoir



3. INSPECTION/ADJUSTMENT

CLUTCH SHOE WEAR

Start engine and check the clutch operation by increasing the engine speed gradually. If the motorcycle tends to creep or the engine stop, check the clutch shoes for wear and replace if necessary.



SUSPENSION

FRONT

Check the action of the front shock absorbers by compressing them several times.

Check the entire shock absorber assembly for oil leaks, looseness or damage.



REAR

Each shock absorber(4) on your scooter has 5 spring preload adjustment positions for different load or riding conditions.

Use a pin spanner(5) to adjust the rear shock spring preload. Position 1 is for light loads and smooth road conditions. Position 3 to 5 increase spring preload for a stiffer rear suspension and can be used when the scooter is heavily loaded.

Be certain to adjust both shock absorbers to the same spring preload positions.

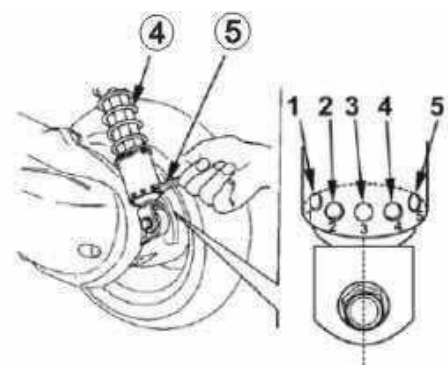

3. INSPECTION/ADJUSTMENT

NUTS/BOLTS/FASTENERS

Check all important chassis nuts and bolts for looseness.

Tighten them to their specified torque values if any looseness is found.

WHEELS/TIRES

Check the tires for cuts, imbedded nails or other damages.

Check the tire pressure.

- * • Tire pressure should be checked when tires are cold.

Tire Pressure

	1 Rider	1 Rider (with passenger)
Front	2.00 kg/cm ²	2.00 kg/cm ²
Rear	2.25 kg/cm ²	2.25 kg/cm ²

Tire Size:

Front 120/80-14 58S
Rear 150/70-13 64S

Check the front axle nut for looseness.

Check the rear axle nut for looseness.

If the axle nuts are loose, tighten them to the specified torques.

Torque:

Front axle nut 2 kg-m
Rear axle nut 12 kg-m

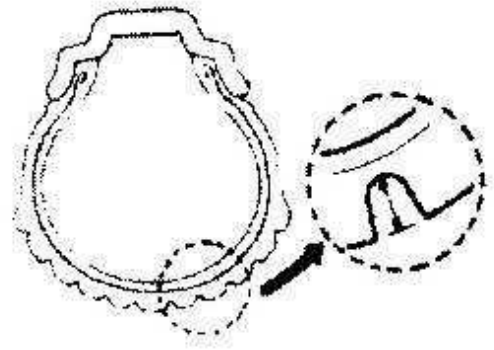

Front Axle Nut



Rear Axle Nut

STEERING HANDLEBAR

Raise the front wheel off the ground and check that the steering handlebar rotates freely.

If the handlebar moves unevenly, binds, or has vertical movement, adjust the steering head bearing.



3. INSPECTION/ADJUSTMENT

SIDE STAND

Your scooter's side stand is not only necessary when you park, but it contains an important safety feature. This feature cuts-off the ignition if you try to ride the scooter when the side stand is down. Perform the following side stand inspection.

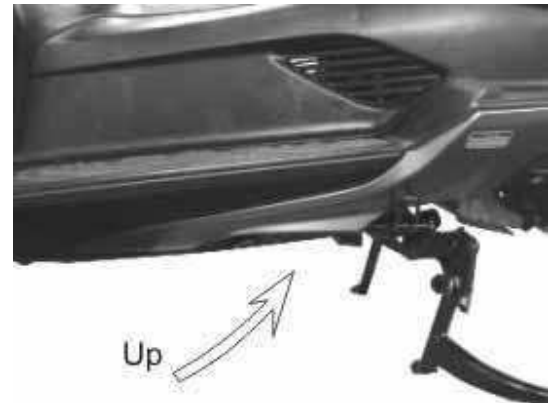

INTERLOCK FUNCTION CHECK

Check the side stand ignition cut-off system,

1. Place the scooter on its center stand.
2. Put the side stand up and start the engine.
3. Lower the side stand. The engine should stop as you put the side stand down.



* If the side stand system does not operate as described, see your KYMCO dealer for service.